

CONSULEDILE
Porte & Finestre



 *Brochure*

Consuledile Srl - Porte & Finestre - www.consuledile.com

tel. 0824/49135 - 337/867047

PIACENTINI 

P O R T E B L I N D A T E

cs Boiserie | pag. 4-27

Pannello interno mm18 sporge dal muro in modo da avere una continuità per realizzare le varie boiserie

Inner panel protrudes 18 mm from the wall in order to have continuity to achieve a variety of panelling

CS FILO MURO | pag. 28-35

Pannello interno mm18 che rimane a filo del muro

Inner panel (18 mm) remains flush with the wall



Due boiserie fisse da 250

Sobria ed elegante nel suo contrasto cromatico, ma soprattutto sicura, tutte le porte blindate sono in classe 3

Two fixed panels of 250

All of the Armored doors are simple yet elegant in their chromatic contrast, but above all are safe







Due boiserie fisse da 500 con sovrapporta da 500
Sulle boiserie fisse possono essere montati interruttori e prese elettriche

Two fixed panels of 500 with a panel above the door
Switches and electrical outlets can be mounted on fixed panels

Una boiserie sx apribile da 360 + una boiserie fissa da 125
Montando la serratura Automatica, possiamo ridurre la ferramenta
interna alla sola maniglia

One wood panel that can be open to the left of 360 + a fixed wood panel of 125
By mounting the automatic lock, we can reduce the internal hardware to just the handle







Una boiserie dx apribile da 250 + una boiserie fissa da 250
Il box della boiserie apribile è predisposto per ospitare diversi allestimenti

One wood panel that can be open to the right of 250 + a fixed wood panel of 250
The box of the openable wood panel is equipped to host various dressings



Il pannello usato, impiallacciato ciliegio a vena orizzontale, si combina con il nuovo design della porta blindata **cs Boiserie**

Two wood panels which can be open of 250
The panel used, veneered with horizontal grain cherry, is combined with the new design of the armored door **cs Boiserie**









Due boiserie apribili da 250, quattro boiserie fisse da 125, due armadi da 500x330
Abbinando degli armadi si ottiene una parete attrezzata, rispondente alle moderne esigenze abitative

Two wood panels that can be open of 250, four fixed wood panels of 125, two wardrobes of 500X330
Combining wardrobes results in a wall unit, meeting to modern housing needs

Una boiserie apribile 250, armadio da 500x330 sx, angolo armadio da 1000x330,
cinque boiserie fisse, 125-125-500-125-125

Nei modelli **cs Boiserie**, **CS FILO MURO**, nulla è lasciato al caso, trasmittanza termica 1,49 Ud, isolamento acustico 42dB

A wood panel which can open 250, wardrobe of 500X330 left, an angled wardrobe of 1000X330,
five fixed panels, 125-125-500-125-125

In the **cs Boiserie** and **CS FILO MURO** models, nothing is left to chance; thermal transmittance 1,49 Ud, acoustic insulation 42 db





Quattro boiserie da 250 fisse, due armadi da 1000x580, con sovrapporte da 250
In questo allestimento si può apprezzare il fine del progetto **cs Boiserie**.
La porta blindata è integrata nella parete con altri mobili, la porta blindata sembra un mobile

Four fixed panels of 250, two wardrobes of 1000X580, with a panel of 250 above the door
In this dressing one can appreciate the final project **cs Boiserie**.
The reinforced door is integrated in the walls with other furniture; the reinforced door is like a piece of furniture





Due boiserie fisse da 250 con sovrapporta da 250
Libreria ad angolo

Two fixed wood panels of 250 with a panel of 250 above the door
Angled bookcase









Due boiserie fisse da 1046
Controsoffitto con lavorazione barocca

Two fixed wood panels of 1046
False ceiling with Baroque finishing



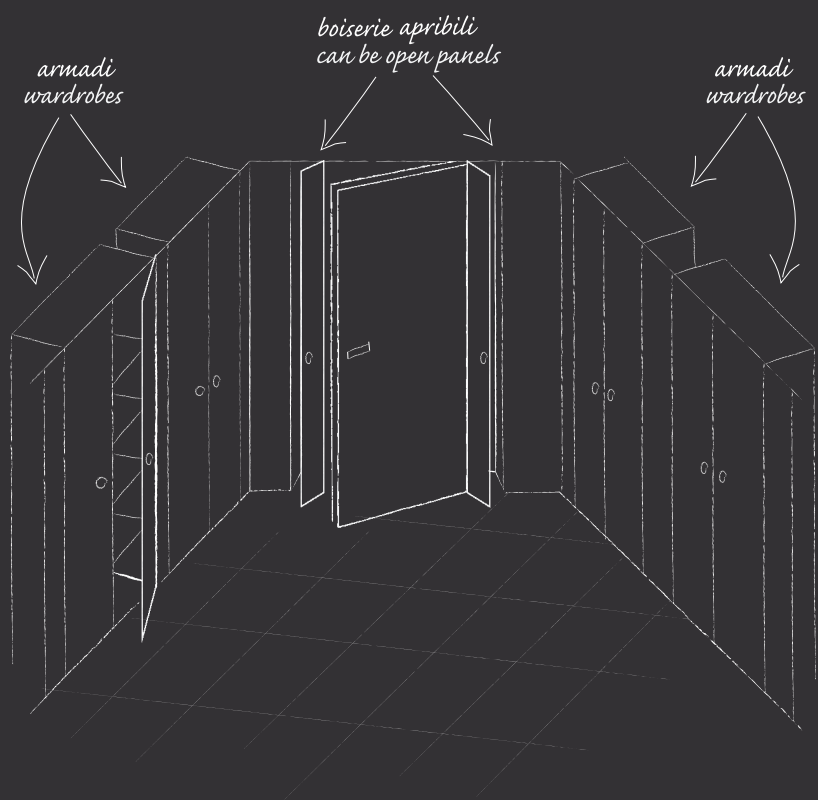

Due boiserie apribili da 250, due boiserie fisse 500, sei boiserie fisse 250, quattro armadi da 1000x580, porta tutta altezza
 Controsoffitto con luci

Two wood panels which can open of 250, two fixed wood panels 500, six fixed wood panels of 25, four wardrobes of 1000X 580, carries all height
 False ceiling with lights





Serie di boiserie fisse da 500
Porta tutta altezza

Fixed panels of 500 series
Door all height





CS FILO MURO

Questa è la soluzione architettonica più innovativa per una porta blindata. Il pannello porta è esattamente a filo muro interno, copre interamente il telaio e non c'è bisogno di mostre.

CS FILO MURO

This is the most innovative architectural solution for a reinforced door. The door panel is exactly flush with the inside wall. It completely covers the frame and there is no need of side panels.





CS FILO MURO Porta tutta altezza

Sui modelli *cs Boiserie* e **CS FILO MURO** è possibile avere il telaio e i braghettoni a colore

CS FILO MURO Door all height

On the *cs Boiserie* and **CS FILO MURO** models it is possible to have the frame and perimeter covering in colour.



CS FILO MURO

Scegliendo il pannello interno "MDF fondo" predisposto ad accogliere qualsiasi finitura muraria, la porta blindata sparisce completamente nel muro.

CS FILO MURO

On choosing the inner panel "MDF Fondo" predisposed to hold whatever wall finishing, the reinforced door completely disappears into the wall.



WINDOWS - SPICER COOKMAN
FINE WINES
ART
GRAPHIC DESIGN REFERENCED
SCOTTS FOX
CLOUTIER JACOBI
FAMES
ANTIQUE
ANTIQUE
THE BOOK OF SYMBOLS
TEXTILE DESIGNERS
FORMULA 1 WORLD CHAMPIONS
THE BOOK OF SYMBOLS
ANTIQUE
ANTIQUE
ANTIQUE

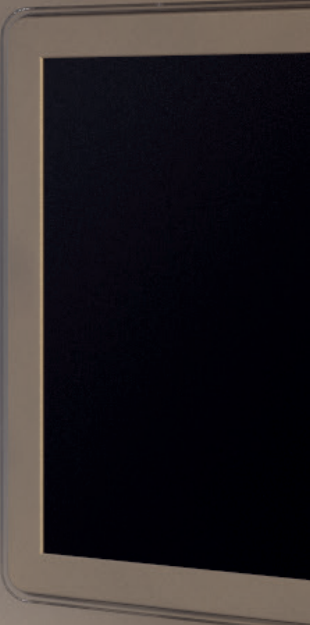





CS FILO MURO *Automatic*

"Stà senza pensieri" serratura Automatica, si chiude da sola ogni volta che uscite

CS FILO MURO *Automatic*

'To be without worries' automatic lock closes on its own every time someone goes out

Listellare impiallacciato mm19 - vena orizzontale
 Veneered slat mm19 - horizontal vein

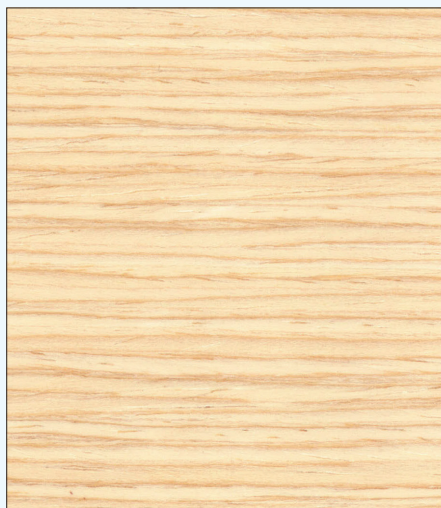

Rovere sbiancato
 Bleached oak

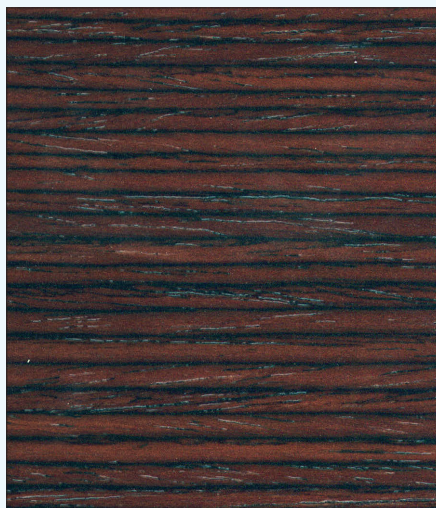

Rovere tinto wengé
 Wenge-stained oak



Rovere grigio
 Grey oak

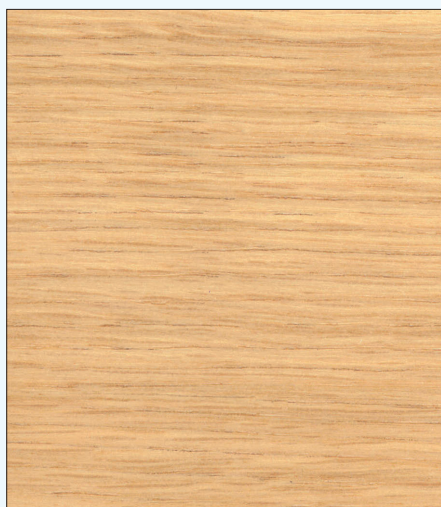

Rovere naturale leggermente tinto
 Natural oak slightly tinted



Noce Nazionale tinto noce medio
 National walnut stained medium walnut

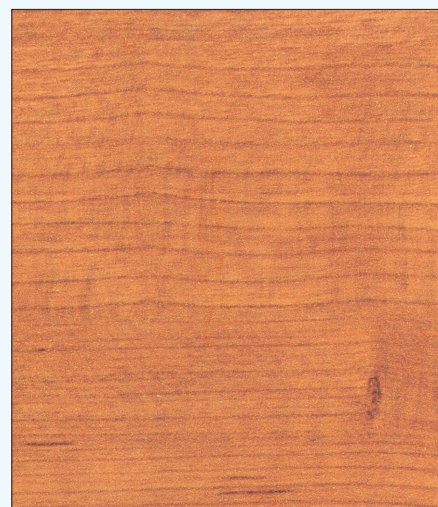

Ciliegio naturale leggermente tinto
 Natural cherry wood slightly tinted

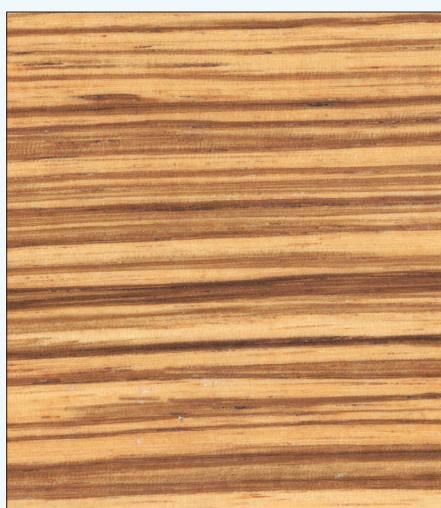

Zebrano naturale leggermente tinto
 Natural zebrano slightly dyed

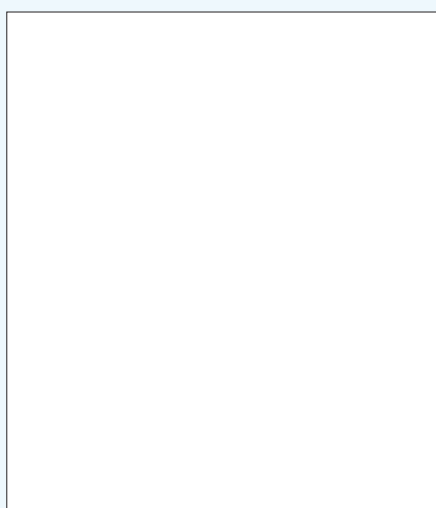

Laccato lucido bianco RAL 9016
 Gloss lacquered white RAL 9016



Colori RAL
 RAL Colours

Nobilitato in laminatino mm18 - vena verticale

Ennobled in laminate mm18 - vertical vein



Grey Rain (tranchè)
Grey Rain (tranche)



Coffee Break (tranchè)
Coffee Break (tranche)



Santos Blue
Santos Blue



Santos White
Santos White

NOTA:
attenzione, la campionatura colori è indicativa, nella realtà i pannelli possono presentare delle differenze.

NOTE:
attention to the colour sampling as it is indicative. In reality the panels may differ.

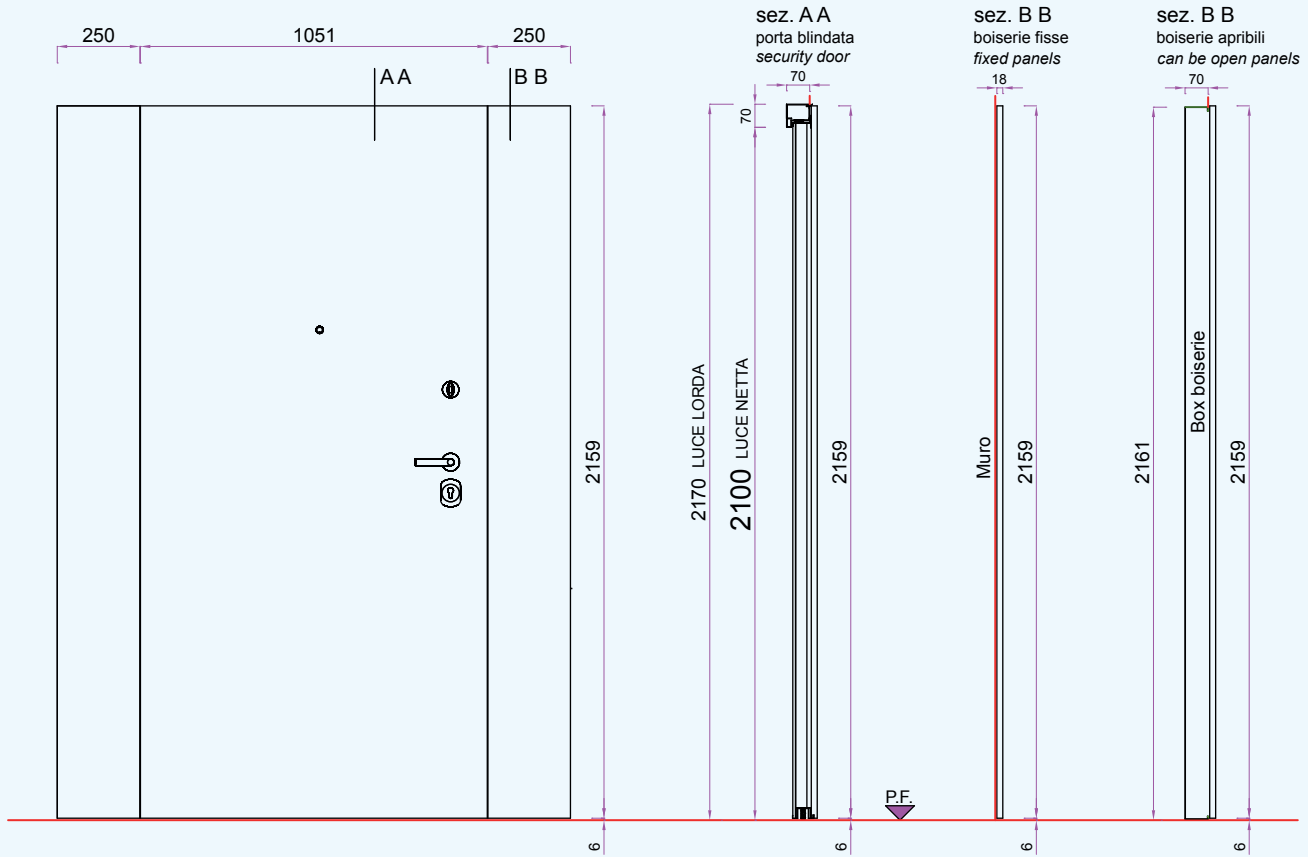

cs Boiserie fisse/fixed

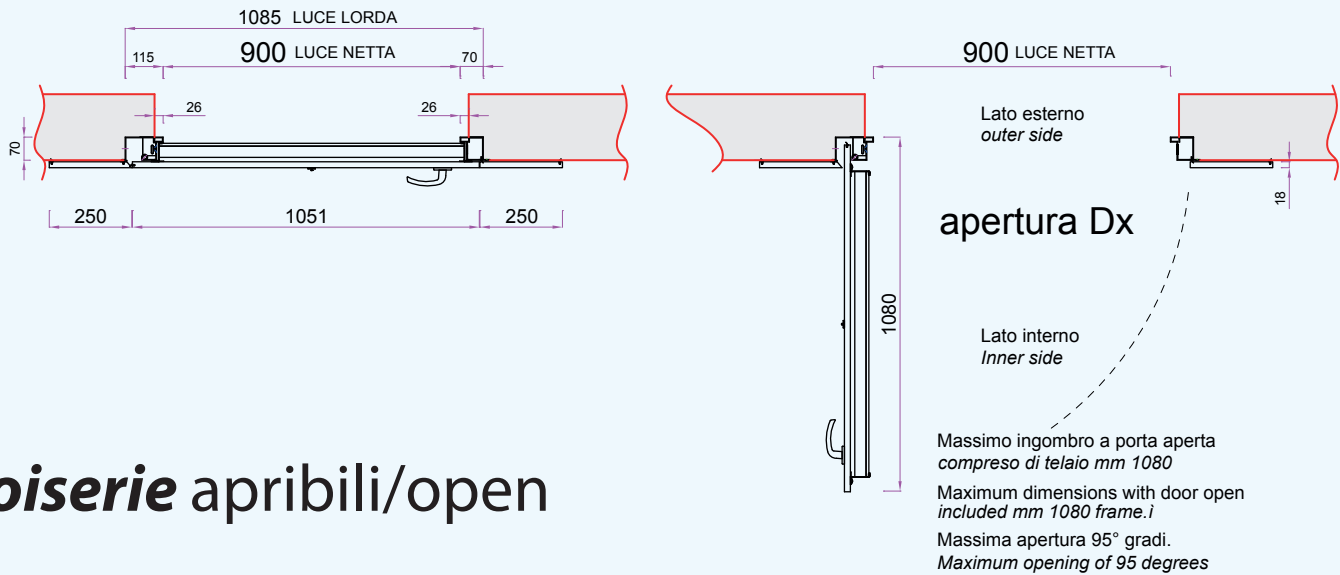

cs Boiserie apribili/open

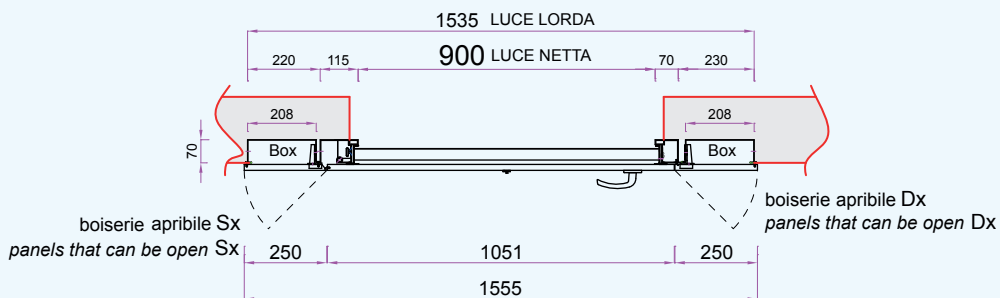

cs *Boiserie* armadi/ wardrobes

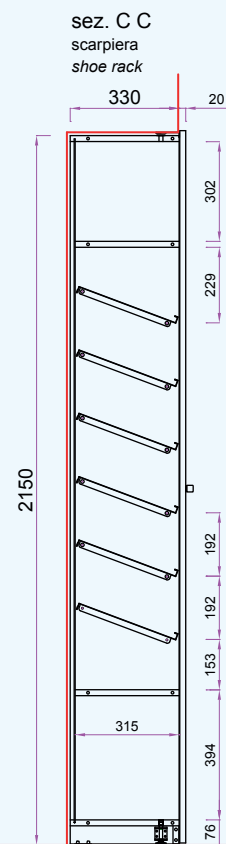
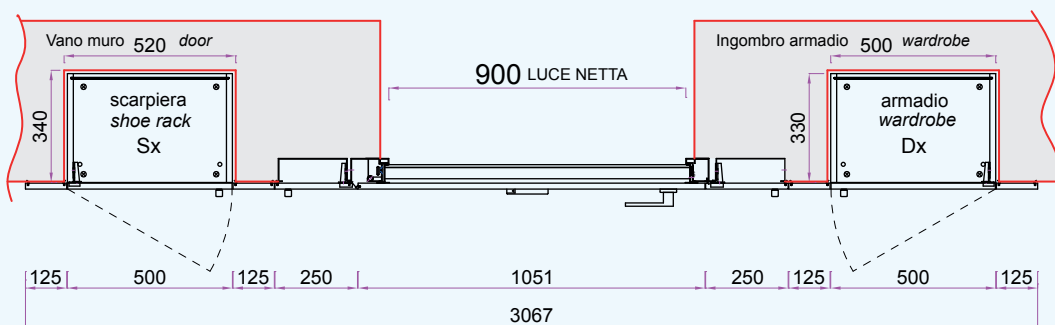
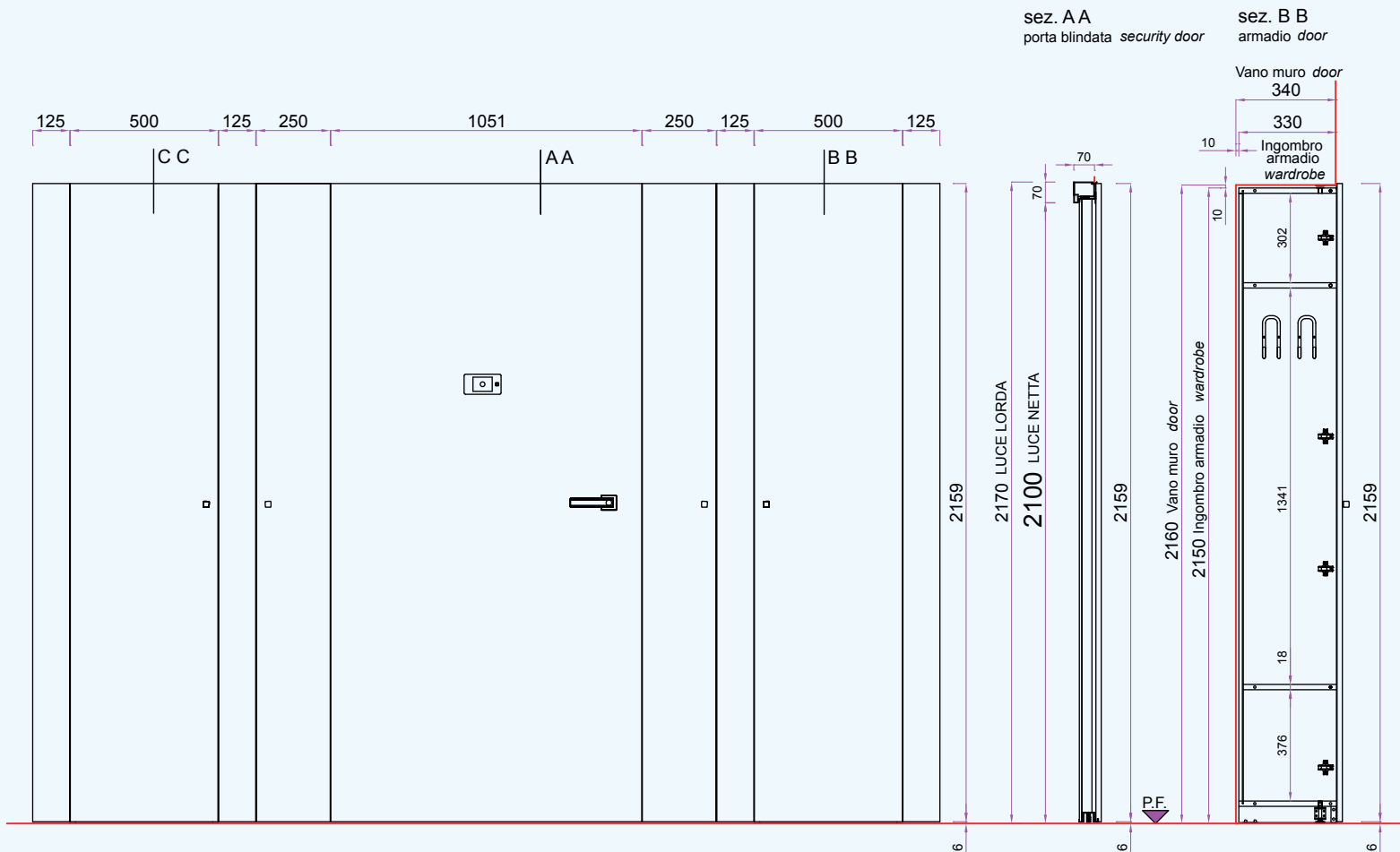

NOTIZIE TECNICHE *cs Boiserie* e **C5 FILO MURD**

Tutti i disegni sono riferiti a porte blindate con luce netta 90x210.

I modelli *cs Boiserie* e **C5 FILO MURD** devono essere montati a filo interno.

Gli armadi non possono essere mai montati a ridosso di una cassamatta.

I sensi di apertura delle boiserie apribili, non possono essere cambiati.

I sensi di apertura degli armadi vengono fatti come da disegno, ma possono essere cambiati.

La tipologia realizzabile è una anta cieca, apertura a tirare, battuta in luce, battuta oltre luce (catalogo generale pag. 257).

I particolari delle cerniere e dei rostri (catalogo generale pag.252).

I rivestimenti esterni, le serrature, i cilindri e le maniglie (catalogo generale pag. 30-191).

TECHNICAL NEWS *cs Boiserie* and **C5 FILO MURD**

The opening directions of the wardrobes are made upon design but can be changed.

The opening directions of the wood panel which can open cannot be changed.

The wardrobes can never be mounted near a door frame and **C5 FILO MURD** need to be mounted flush internal *cs Boiserie* models.

All designs are referred to reinforced doors with net light 90X210

The type feasible is windowless door, pull opening, internal door leaf, external door leaf (General catalogue, pag. 257)

The details of the joints and the wedge locking elements' (General Catalogue, pag. 252)

The external coatings, the locks, the cylinders and the handles (General catalogue, pag. 30-191)

CS FILO MURO

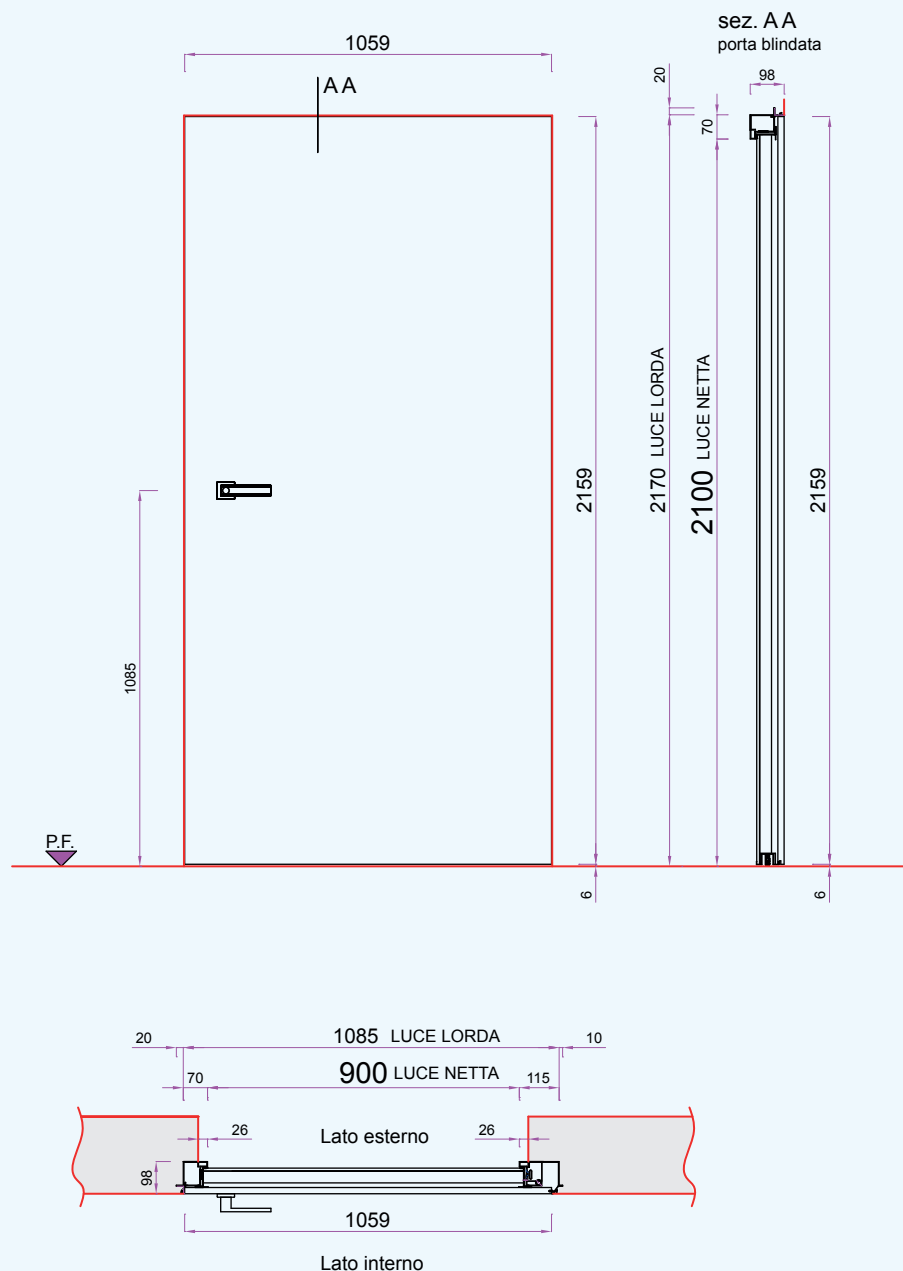

RISULTATO PROVE TIPO SU MODELLI *cs Boiserie* CS FILO MURO: TEST RESULTS ON MODELS *cs Boiserie* CS FILO MURO:

Antieffrazione	Uni En 1627-30, metodo di prova e classificazione	classe 3
Permeabilità all'aria	Uni En 1026 metodo di prova, Uni En 12207 classificazione	classe 2
Resistenza al vento	Uni En 12211 metodo di prova, Uni En 12210 classificazione	classe C5
Trasmittanza termica	Uni En Iso 10077/1-2 metodo di prova, risultato	Ud = 1,49 W/m²K
Isolamento acustico	Uni En Iso 140/3 metodo di prova, En Iso 717-1, risultato	Rw 42 dB

Burglarproof	Uni En 1627-30 test method and classification	class 3
Permeability to air	Uni En 1026 test method, Uni En 12207 classification	class 2
Resistance to wind	Uni En 12211 test method, Uni En 12210 classification	class C5
Thermal transmitting	Uni En Iso 10077/1-2 test method, results	Ud = 1,49 W/m²K
Acoustic insulation	Uni En Iso 140/3 test method, En Iso 717-1, results	Rw 42 dB

NOTE

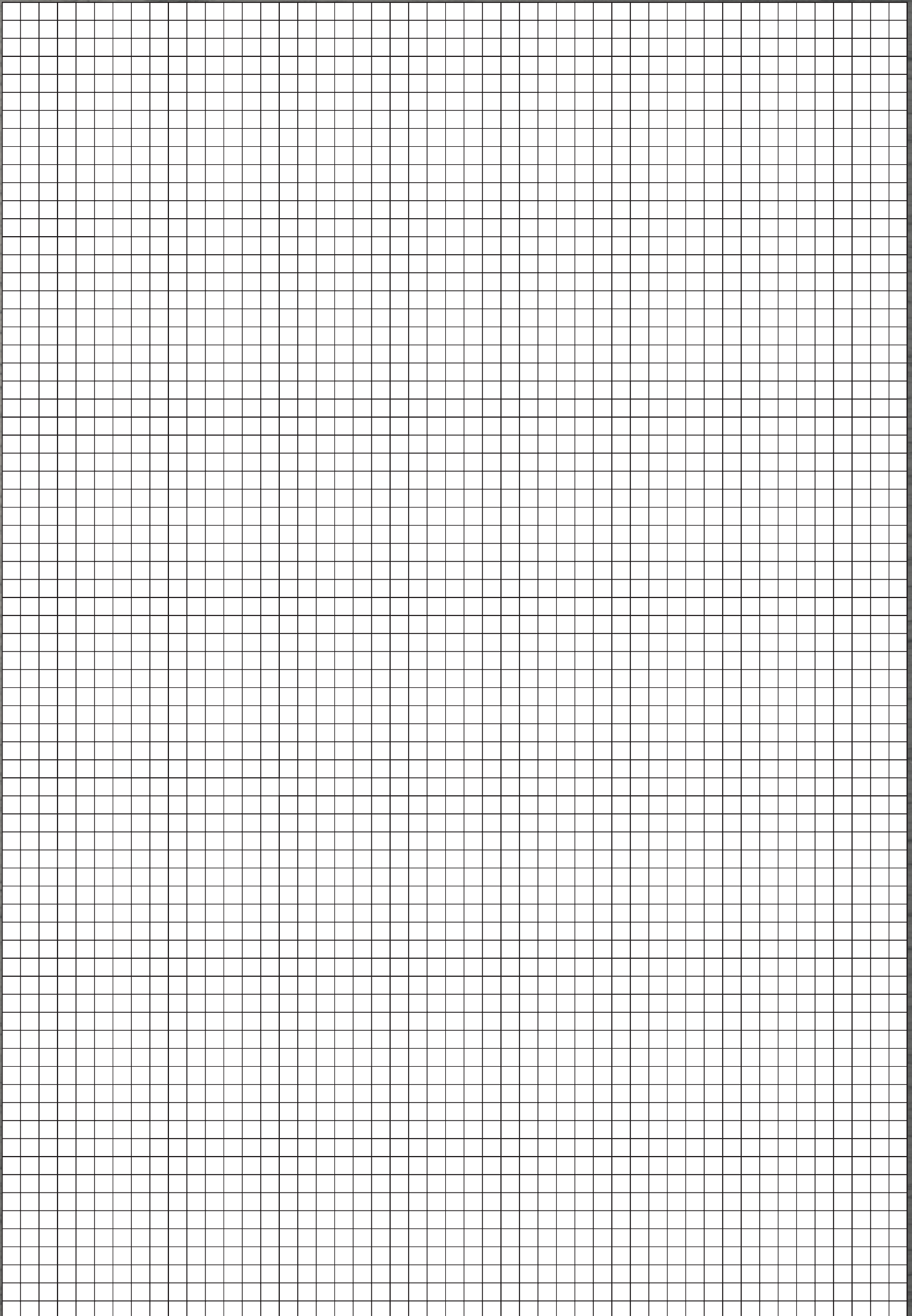

PIACENTINI



P O R T E B L I N D A T E

SISTEMI FISICI DI SICUREZZA

PIACENTINI srl Via Tirino, 85 - 66100 CHIETI, (CH)
Telefono 0871 / 562090 - Fax: 0871 / 564651
www.piacentinisrl.it - e-mail: info@piacentinisrl.it

Numero Verde

800 251238

Piacentini s.r.l. si riserva di apportare in qualsiasi momento modifiche a prodotti, misure e materiali, che ritenesse utili per esigenze di carattere produttivo e commerciale. Le tonalità di colore e le finiture illustrate vanno considerate puramente indicative. Verificare sempre la fattibilità dell'abbinamento dei rivestimenti, finiture, chiusure e optional consultando il listino e le cartelle campioni.

Piacentini s.r.l. reserves the right to make any changes to products, dimensions and materials at any time deemed useful for manufacturing and sales purposes. The colour shades and finishes illustrated herein are to be considered purely indicative. Always check the feasibility of finish combinations, covers and optional by consulting the price list contents and sample folds.

